

 ICOM

HF/50MHz TRANSCEIVER

IC-7800

THE MASTERPIECE

RF Technical Excellence and
Craftsmanship Unparalleled.



Icom Inc.

From 40 years of RF design expertise comes the Masterpiece Ham Radio Transceiver

Icom is a pioneer in the amateur radio world. Starting with the first analog PLL circuit in the IC-200 to the ground-breaking 32-bit DSP technology used in the IC-756PRO, Icom's developed some of the most innovative radio equipment ever made. Continuing with this tradition, Icom announces the ground-breaking IC-7800!

The IC-7800's somewhat familiar looks will remind many HF operators of the IC-781. The IC-781 set benchmarks back in the 1980's as that generation's ultimate HF transceiver. Some of today's operators still feel the IC-781 is the pinnacle in amateur radio design. They have not seen the IC-7800. It takes amateur radio to a whole new level of performance. The IC-7800 will be viewed as the pinnacle radio for years to come.

The IC-7800 is an artistic fusion of over 40 years analog RF circuit development expertise and cutting-edge digital technology. The result is TWO identical receivers with 110dB dynamic range, +40dBm 3rd order intercept point, and unmatched DSP technology in the HF bands something that has never been achieved in Ham radio!

Simply put, Icom has developed the ultimate Amateur HF transceiver. No one else comes close!

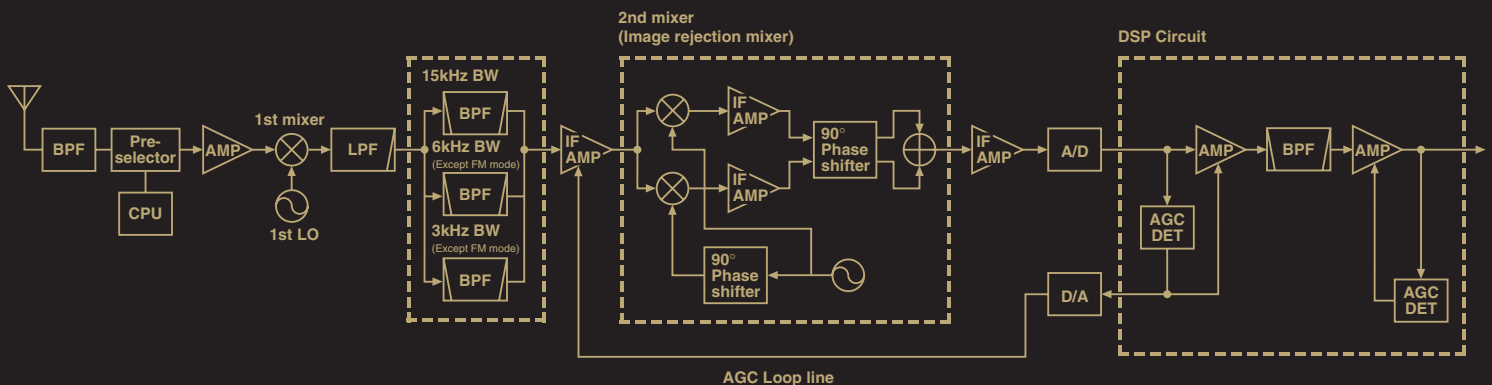

+40dBm IP3 (3rd order Intercept Point)

Icom's considerable analog RF circuit experience combined with cutting-edge digital technology results in an astonishing 110dB receiver dynamic range and a +40dBm IP3 in the HF bands. A first in Ham radio! To achieve this superior receiver performance, Icom's engineering team completely re-engineered the whole analog circuit and matched it to the DSP units. This allowed us to explore new technical dimensions.

Dynamic range characteristics

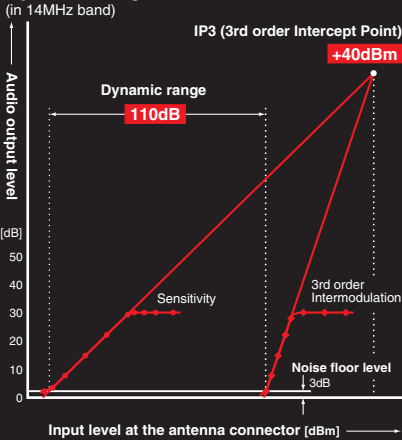

Internal distortion reduction

The IC-7800 uses durable mechanical relays for BPF switching instead of non-linear semi-conductors, like switching diodes which can cause distortion. The mechanical relay reduces secondary distortion at the primary stage of signal processing.

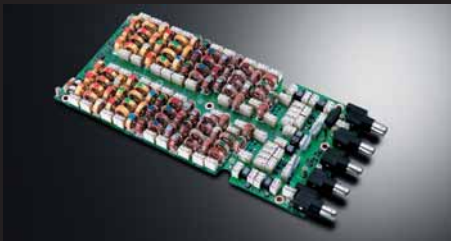

BPF unit

Improved blocking

Contesters know how frustrating it is to experience a strong adjacent signal that's blocking the receiver from pulling out a weaker signal. Before the 1st amplifier, the IC-7800's three roofing filters block strong adjacent signals. You can select the filter widths from 15kHz, 6kHz and 3kHz, depending on operating mode. (FM mode is fixed to 15kHz.)



Three roofing filters

Icom's DIGI-SEL

The pre-selector works between 1.5MHz and 30MHz and rejects distortion components de-

rived from out of band interference such as multi-multi operation or strong broadcast stations. It automatically tracks the intended signal keeping the pre-selector's bandwidth centered on the operating frequency. The center frequency of the pre-selector is manually adjustable from the DIGI-SEL tuning knob on the front panel.



DIGI-SEL unit

DIGI-SEL Characteristics in the 14MHz band

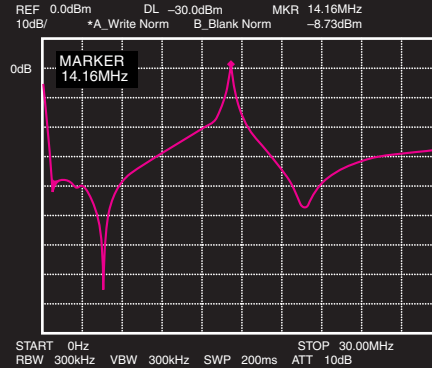

Less internal phase noise

Simple receiver system configuration is the best way to eliminate sources of the spurious signals and distortion from transceivers. The IC-7800 uses a double conversion system composed of a D-MOS FET 1st mixer and a newly developed image rejection mixer for the 2nd stage. The 1st mixer stage is driven with a signal from the high-drive Local Oscillator with excellent C/N. The image rejection mixer for the 2nd stage reduces signal distortion through IF processing and provides a high-fidelity signal to the DSP unit. This system provides wide dynamic range, reducing the distortion from strong signals and lower intermodulation.

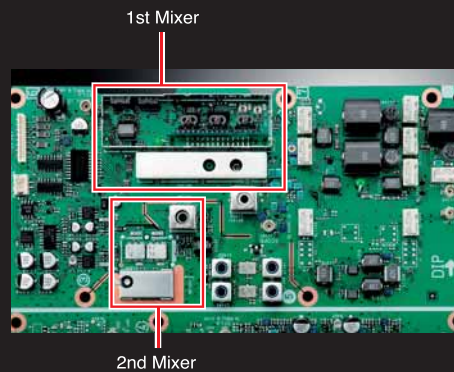

Multiple AGC loops

The IC-7800 has multiple AGC loops. The AGC voltages detected in front of and behind the digital IF filter in the DSP unit. The first AGC loop

prevents saturation of the 1st IF amplifier. The other AGC loop detects the AGC voltage at the digital IF filter output which has only passed the intended signal and draws the full potential from the digital IF filter. Combining the digital IF filter, manual notch, and the 1st IF stage, these are all controlled by the DSP unit. 110dB of ultra wide dynamic range in the receiver means the IF amplifier is distortion free from strong signals.

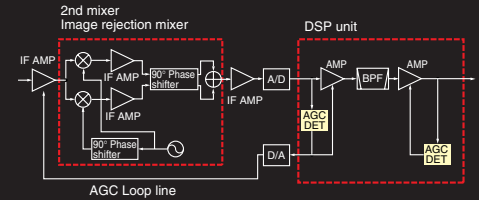

Full AGC controls

The IC-7800 accommodates both the "on-the-fly" operator as well as the most avid "tweaker" operator by providing tunable AGC preset and manual AGC level controls. The AGC time constants can be set in the 3 presets (slow, medium and fast), adjustable from 0.1-6 sec. (0.3-8 sec. at AM) delay. Then the addition of the AGC VR control enables the user to "tweak" or fine tune the AGC reaction time.

AGC						
	SSB	CW	RTTY	PSK	AM	FM
FAST	0.3	0.1	0.1	0.1	3.0	0.1
MID	1.2	0.5	0.5	0.5	6.0	---
SLOW	6.0	1.2	1.2	1.2	7.0	---

(sec.)

AGC setting screen

Digital IF filter

The IC-7800 incorporates the "build your own" filter. This allows the operator to adjust filter shaping (sharp or soft), filter bandwidth, and center frequency characteristics, without missing the action. Multiple filter memories store the last used filter settings by using operation mode. This allows the operator to quickly switch filters for constant operating conditions, such as in a contest. Icom's digital IF filters give you performance that is not possible with crystal or mechanical filters.



Filter preset screen.

Digital twin PBT (Passband Tuning)

Once the IF filters have been "tweaked", the operator has additional control with the digital twin PassBand Tuning (PBT). The digital twin PBT allows flexibility of both the IF shift and narrowing of the digital IF passband by moving the IF passband. With the digital IF filters, PBT performance allows you to cut away all the interference and noise to hear the actual signal.

In addition to the filter preset menu, the LCD indicates the twin PBT conditions across the top of the screen, so you can still use the lower portion of the TFT display for other radio operations.

Digital manual notch filter

In recent years, HF operators have marveled at how well DSP reduces interfering signals and noise. Signals such as heterodynes and AM Carriers can be eliminated with Automatic Notch filter technology. Making interference from RF sources such as beat signals and RTTY signals is a thing of the past. Additionally, the filter shape of the Manual Notch can be adjusted in three steps, with more than 70dB of attenuation!

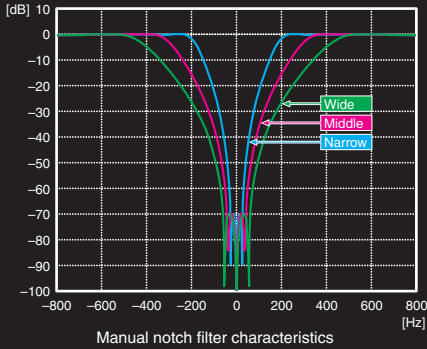

Variable level noise reduction

The 32-bit DSP processing power of the IC-7800 produces real results by separating a signal component from the noise with the variable noise reduction. By suppressing the noise components, an outstanding signal-to-noise ratio is achieved, providing clean, clear audio in all modes without distortion of the target signal.

Adjustable noise blanker

A newly designed, digital noise blanker significantly reduces pulse type noise. As part of the 32-bit DSP function, there are three adjustments: threshold level, blank time parameter, and attenuation level.

50MHz band preamplifier and mixer

The IC-7800 was designed with the 6m aficionado in mind. Rather than sharing circuits used for HF, a separate preamplifier and mixer was designed especially for 6m. This greatly improves the receiver sensitivity by reducing inter-

modulation characteristics, enabling weak signal work without distortion or interference from strong signals in the band.

Quad processing

The IC-7800 incorporates four independent, 32-bit floating DSP units and 24-bit AD/DA converters. By having four independent DSP units, the radio will respond to operator changes in an instant, as each DSP unit has a dedicated function. While there is one for each receiver, this includes the AGC and Filter controls, there is a DSP unit for transmit as well as a DSP unit for the Spectrum Scope.



DSP Unit

Two completely independent receiver circuits

The IC-7800 incorporates two completely independent receivers, from the antenna inputs all



the way though to the stereo headphone or individual external speaker outputs. All the performance of the first receiver is duplicated for a perfectly matched set of "Twins". When connected to external stereo headphone, main and sub receiver audio can be mixed or separated to right and left.

Real time spectrum scope

With its introduction in the IC-781, having a spectrum scope in an HF radio changed the way HF operators "see" the band! Due to the DSP unit for the scope, the IC-7800's spectrum scope provides excellent sensitivity, with 80dB of dynamic range. While the scope rivals many of today's commercial test sets, there are 7 steps, ranging from ± 2.5 to ± 250 kHz. This is up to 500kHz of spectrum!

Also, there is a setting to allow for specific scope edges or center the span on the receiving frequency. In addition to these features, the scope has 3 levels of attenuator (10dB, 20dB, 30dB), 3 types of reference markers (main receiver, sub receiver, transmit), 3 levels of sweep speed (slow, mid, fast), peak hold and main/sub band one touch switch.

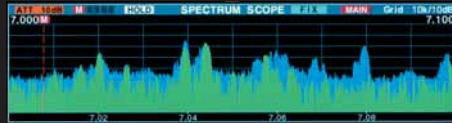
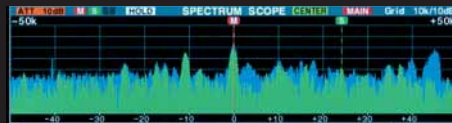

Ultra high stability OXCO unit

The IC-7800 uses the OXCO (Oven Control Crystal Oscillator) unit which is stable to within ± 0.05 ppm

at 0°C to 50°C. This specification means that even on the 50MHz band, frequency error is less than 2.5Hz! In addition, a 10MHz reference frequency can be input and output for accurate tuning.



OXCO Unit

Central Control

In the heat of a big contest or a DX-pedition, control placement is extremely important as every second counts. So Icom took a proven system, the IC-781, and used the basic front panel design for the IC-7800, incorporating improvements for all the new features and controls. Often used functions, including RF power and key speed have independent large knobs for easy access. The "XFC" button is placed efficiently for holding the button by the left hand, and moving the main dial with the right hand.



The above photo shows actual size.

7-inch wide color TFT LCD

While Icom's RF engineering team reviewed receiver designs for how the IC-7800 hears a signal, close attention was also paid to how the operator sees a signal. Details such as response time, color, resolution, and visibility were extremely important. Thus, an active matrix 7-inch (800x480 pixel) TFT color display was selected for the IC-7800.

This large display shows main, sub-band frequencies, including various settings, and operating conditions, as well as the spectrum scope, S-meter, and RTTY/PSK31 decoded messages. The "virtual" S-meter shows smooth and accurate analog-looking needle swings whose response is selectable from 3-steps (fast/mid/slow). In addition to the "virtual" meters, the IC-7800 has digital multi-function bar graphic meters to show various conditions, including transmitter PA temperature and voltage. If a larger display is desired, the IC-7800 has a VGA connector for an external monitor and an S-meter connector for an external analog S-meter.



MEMORY			
1	1,825,000	CW	FIL2 160 DXSPOT
2	3,595,000	CW	FIL2 80M DXSPOT
3	3,759,000	LSB	FIL1 75M DXSPOT
4	7,005,000	CW	FIL2 40M DXSPOT
5	7,080,000	LSB	FIL1 40M DXSPOT
6	10,105,000	CW	FIL2 30M DXSPOT
7	14,025,000	CW	FIL2 20M DXSPOT
8	14,000,000	RTTY	FIL2 20M DXSPOT
9	14,195,000	USB	FIL1 20M DXSPOT
10	18,075,000	CW	FIL2 17M DXSPOT
11	18,145,000	USB	FIL1 17M DXSPOT
12	21,025,000	CW	FIL2 15M DXSPOT
13	21,080,000	RTTY	FIL3 15M DXSPOT
14	21,255,000	USB	FIL1 15M DXSPOT
15	24,895,000	CW	FIL2 12M DXSPOT

Memory list screen (Wide setting)

RTTY/PSK31 operation without PC connection

Another amateur radio first is the capability of receiving and transmitting RTTY and PSK31 without the aid of a computer. While decoded RTTY and PSK31 is shown on the 7-inch display, simply connect a USB keyboard to the IC-7800 to send as well. To reduce errors in receiving RTTY, the IC-7800 has a digital twin peak filter to reduce interference from other signals in the band. In the PSK mode, the AFC function tracks the receiving signal for accurate tuning and the NET function allows you to send at the shifted frequency. In addition, a total 8 channels of RTTY and PSK31 transmit memory stores up to 70 characters of often used messages for each channel.



200W output power at full duty cycle

The newly designed push-pull power amplifiers using power MOS-FETs work on 48V DC. They provide a powerful 200W output power at full duty cycle and low transmit intermodulation. An effective cooling system maintains internal temperatures within a safe range and prevents thermal runaway.



PA unit and heat sink



PA unit (close up)

Microphone equalizer

One of the four 32-Bit DSP units is used for adjusting the transmit audio. Digitally tweak your transmit audio with the separate bass and treble controls for incredible sounding audio. This built-in audio equalizer has a total of 121 combinations for each phone mode, so you can master the warm, full audio you want. In addition to the equalizer, a new parametric transmit bandwidth for the SSB mode allows the operator to set both the high- and low-pass filter limits. (100, 200, 300, 500 for the high-pass and 2.5, 2.7, 2.8 and 2.9 kHz for the low-pass). Then store the filter settings into the three bandwidth memories. The operator may now go from DX to rag chew audio with the push of a button.

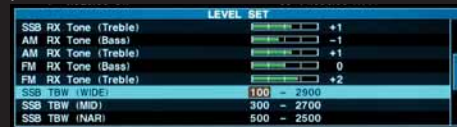

RF speech compressor

The IC-7800 utilizes the 32-bit DSP for the RF speech compressor providing the maximum punch without the fuzzy sound. It's great for breaking through the noise and hash to complete the QSO.

CF memory card

Making big scores means keeping your team fresh on those long DX-peditions or Multi Op contests. Swapping out operators usually involves time-wasting radio tweaks, because each operator has their own favorite settings to best

match their operating style. This all changes with the CF memory card! Prior to a contest, operators may record their preferred IC-7800 settings such as filter, Digital Voice Recorder (DVR) memories, antenna settings, etc. When it's their turn to operate, simply insert their CF card into the IC-7800. In a flash, the '7800 is now "their rig", and there's nearly zero down time!

Digital voice recorder

The IC-7800's Digital Voice Recorder (DVR) is a very convenient function for contests, DX-peditions, and even normal operation. Record your call sign, CQ, or contest number in up to four memory locations. A total of 90 seconds is available for the four memories, with each memory channel being soft partitioned to allow custom recording sizes.

The front panel control of the DVR allows you to record incoming signals up to 200 seconds for 20 channels (Max. 30 sec. per channel). The playback automatically mutes the receiver for clear playback of the previous 15 seconds of recorded audio. It's the perfect feature for those contest operators wanting to improve their UBN reports.

Digital IF data filter

For the AFSK operators, the IC-7800 automatically adjusts its digital IF filters for optimum settings. When the digital IF filters are adjusted to 500Hz or less in SSB or SSB-D, the sharp CW bandpass filter (BPF) is selected and the 1/4 tuning step is selected.

4 antenna connectors

For the ultimate in antenna control, the IC-7800 has 4 antenna connectors with a programmable automatic antenna selector. Each antenna connector can be customized to the antenna usage type, such as a beam for TX and a beverage antenna for RX, as well as to specific antenna/band configurations.

ANT				(ANT) Switch
0.00 - 1.60	1	15.00 - 20.00	3	Auto
1.60 - 2.00	1	20.00 - 22.00	3	
2.00 - 6.00	1	22.00 - 26.00	3	
6.00 - 8.00	2	26.00 - 30.00	3	
8.00 - 11.00	2	30.00 - 45.00	1	
11.00 - 15.00	3	45.00 - 60.00	3	

Temporary Memory : ON

Antenna memory setting screen

Complete CW features

All of the following CW capabilities are included in the IC-7800:

- DSP controlled CW keying waveform shaping
- Multi-function electronic keyer with adjustable keying speed from 6-60 wpm, dot-dash ratio from 1:1:2.8 to 1:1:4.5 and paddle polarity
- CW pitch control from 300 to 900Hz (5Hz pitch)
- CW-Reverse mode operation with selectable normal (default) carrier point
- Double key jack system (front and rear panel)
- Full break-in and semi-break-in functions
- CW/AM auto tuning function helps to zero in on intended signals within ±500Hz range
- 4 channels of memory keyer with 70 characters of transmit memory
- Bug keyer and microphone up/down keyer

Other outstanding features

[Antenna line]

- High speed automatic antenna tuner covers HF and 50MHz bands.
- BNC type Rx In/Out connectors for receiver antenna or external attenuator, etc.

[Receiver]

- General coverage receiver covers from 30kHz to 60MHz (*Some frequency bands are not guaranteed. Depending on version.)
- Two types of receive preamplifiers:
Preamp 1; Increase low level signal improving intermodulation characteristics
Preamp 2; High gain preamplifier
- Built-in receive audio equalizer tweaks receive audio with the separate bass and treble controls
- 7-step attenuator (3, 6, 9, 12, 18, 21dB and OFF)
- External speaker connectors for main and sub receiver

[Transmitter]

- Tx monitor
- 50 CTCSS tone encoder and decoder
- VOX capability (Voice operated transmission)
- All mode power control

[Operation]

- Set mode function for flexible and speedy setting
- Memory pad stores up to 5 or 10 operating frequencies
- Quick split function and frequency lock function for split operation
- Triple band stacking register
- SSB/CW synchronous tuning
- Single knob control from squelch to RF gain
- RIT and Δ Tx variable up to 9.999kHz
- 1Hz pitch tuning and indication
- 101 memories with 10-character alphanumeric
- Auto tuning step function
- Firmware update capability from your PC

- Built-in voice synthesizer announces operating frequency, mode and signal strength.
- Programmed scan, memory scan, select memory scan, VSC scan and Δ F scan
- Main dial tension control
- CI-V interface capability
- Optical digital audio input/output
- FFT scope averaging function for both PSK and RTTY decoder
- BNC type Transverter connector
Offset frequency is user programmable and actual frequency is displayed.
- UTC/Local Clock and timer function
- Screen saver function

Supplied accessories:

- CF memory card
- AC power cable
- Spare fuses
- Speaker plugs
- Key plug
- ACC plugs
- Power plug
- Pin plug
- Rack mount handles

Rear panel view

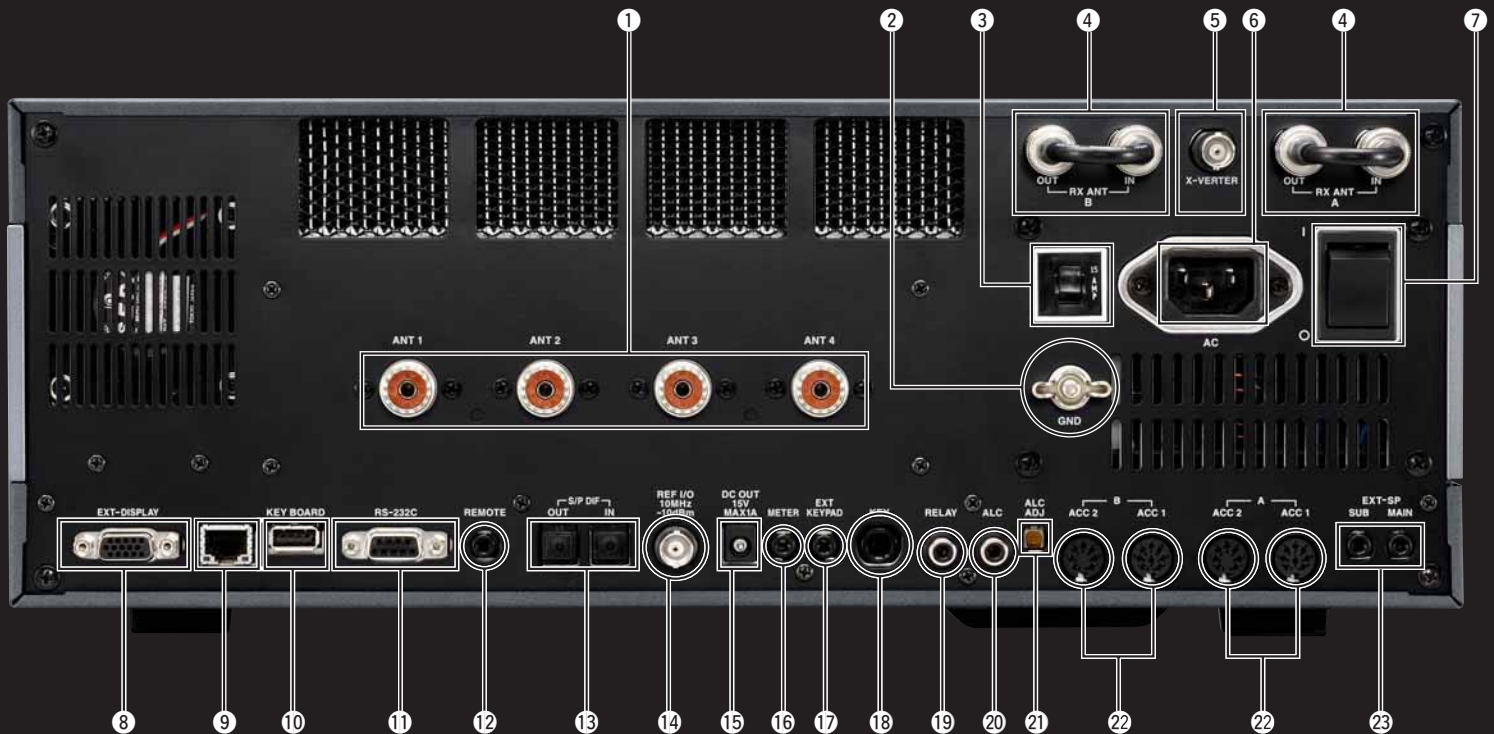

① Antenna Connectors

② Ground Terminal

③ Breaker Switch

④ Receive Antenna Connectors A/B

⑤ Transverter Jack

⑥ AC Power Cord Receptacle

⑦ Main Switch

⑧ External Display Connector (VGA)

⑨ Ethernet Connector

⑩ USB Keyboard Connector

⑪ RS-232C Connector

⑫ CI-V Remote Control Jack

⑬ S/P DIF In/Out Jacks

⑭ Reference Frequency In/Out Jack

⑮ External DC Output Jack

⑯ S-meter Output Jack

⑰ External Memory Keypad Jack

⑱ Key Jack

⑲ Tx/Rx Control Jack (Relay)

⑳ ALC Input Jack

㉑ ALC Level Pot

㉒ ACC Sockets A/B

㉓ External Speaker Jacks

SPECIFICATIONS

GENERAL

- Frequency coverage*1 :
U.S.A. Version
Rx 0.030–60.000MHz*2
Tx 1.800– 1.999MHz 3.500– 3.999MHz
5.3305, 5.3465, 5.3665, 5.3715, 5.4035MHz*3
7.000– 7.300MHz 10.100–10.150MHz
14.000– 14.350MHz 18.068–18.168MHz
21.000–21.450MHz 24.890–24.990MHz
28.000–29.700MHz 50.000–54.000MHz
- Europe Version
Rx 0.030–60.000MHz*2
Tx 0.1357–0.1378MHz 1.810– 1.999MHz
3.500– 3.800MHz 7.000– 7.100MHz
10.100– 10.150MHz 14.000–14.350MHz
18.068– 18.168MHz 21.000–21.450MHz
24.890– 24.990MHz 28.000–29.700MHz
50.000– 52.000MHz

*1 Frequency ranges vary depending on version.

*2 Some frequency ranges are not guaranteed.

*3 Carrier point frequency.

- Mode : USB, LSB, CW, RTTY, PSK31, AM, FM
- Number of channels : 101 (99 regular, 2 scan edges)
- Antenna impedance : 50Ω unbalanced (Tuner off)
- Antenna connector : SO-239×4 and BNC×2
- Power supply requirement : 85–265V AC
- Temperature range : 0°C to +50°C; +32°F to +122°F
- Frequency stability : Less than ±0.05ppm
(0°C to +50°C, after warm up)
- Frequency resolution : 1Hz (minimum)
- Power consumption : Tx Max. power 800VA
Rx Stand-by 200VA (typ.)
Max. audio 210VA (typ.)
- Dimensions : 424(W)×149(H)×435(D) mm;
(projections not included) 16¹¹/₁₆(W)×5⁷/₈(H)×17¹/₈(D) in
- Weight (approx.) : 25kg; 55lb

TRANSMITTER

- Output power (continuously adjustable) :
SSB, CW, RTTY, PSK31, FM 5–200W
AM 5–50W
137kHz, CW* More than –20dBm
(* Depending on version.)
- Modulation system :
SSB DPSN modulation
AM Digital low power modulation
FM Digital phase modulation
- Spurious emission : More than 60dB (HF bands)
More than 70dB (50MHz band)
- Carrier suppression : More than 63dB
- Unwanted sideband suppression :
More than 80dB
- ΔTX variable range : ±9.999kHz
- Microphone impedance : 600Ω (8-pin connector)

FM (BW: 15kHz at 12dB SINAD)

28–29.999MHz 0.5μV*1

50.0–54.0MHz 0.32μV*2

*1 Pre-amp 1 is ON, *2 Pre-amp 2 is ON.

- Squelch sensitivity (Pre-amp: OFF):
SSB, CW, RTTY, PSK31 Less than 5.6μV
FM Less than 1μV
- Selectivity (representative value):
SSB (BW: 2.4kHz) More than 2.4kHz/–3dB
Less than 3.6kHz/–60dB
More than 500Hz/–3dB
CW (BW: 500Hz) Less than 700Hz/–60dB
More than 360Hz/–6dB
RTTY, PSK31 (BW: 350kHz) Less than 650Hz/–60dB
AM (BW: 6kHz) More than 6.0kHz/–3dB
Less than 15.0kHz/–60dB
FM (BW: 15kHz) More than 12.0kHz/–6dB
Less than 20.0kHz/–60dB
- Spurious and image rejection ratio : More than 70dB
- Audio output power : More than 2.6W at 10% distortion
with an 8Ω load
- RIT variable range : ±9.999kHz
- PHONES connector : 3-conductor 6.35 (d) mm (1/4")
- EXT SP connector : 2-conductor 3.5 (d) mm (1/8")
/8Ω×2 (For main and sub bands)

RECEIVER

- Receive system : Double conversion
super-heterodyne system
- Intermediate frequencies :
1st 64.455MHz (Main receiver)
64.555MHz (Sub receiver)
2nd 36kHz
- Sensitivity (typical) :
SSB, CW, RTTY, PSK31 (BW: 2.4kHz at 10dB S/N)
0.1–1.799MHz 0.5μV*1
1.8–29.999MHz 0.16μV*1
50.0–54.0MHz 0.13μV*2
AM (BW: 6kHz at 10dB S/N)
0.1–1.799MHz 6.3μV*1
1.8–29.999MHz 2μV*1
50.0–54.0MHz 1μV*2

All stated specifications are subject to change without notice or obligation.

The LCD display may have cosmetic imperfections that appear as small or dark spots. This is not a malfunction or defect, but a normal characteristic of LCD displays.

OPTIONS



HF+50MHz 1kW LINEAR AMPLIFIER
Covers all HF and 50MHz bands, provides clean, stable 1kW output. Automatic antenna tuner and compact detachable controller are standard. 2 exciter inputs and 4 antenna connectors are available.



SP-20 EXTERNAL SPEAKER
4 audio filters; headphone jack; can connect to 2 transceivers.
Input impedance: 8Ω
Max. input power: 5W



SM-20 DESKTOP MICROPHONE
Unidirectional, electret microphone for base station operation. [UP/DOWN] switches and a low cut function are available.



HM-36 HAND MICROPHONE
Hand microphone with [UP/DOWN] switches.



CT-17 CI-V LEVEL CONVERTER
For remote transceiver control in the remote jack using a PC equipped with an RS-232C port.

Icom Inc.

1-1-32, Kami-minami, Hirano-ku, Osaka 547-0003, Japan Phone: +81 (06) 6793 5302 Fax: +81 (06) 6793 0013 URL: <http://www.icom.co.jp/world/index.html>

Count on us!

Icom America Inc.

2380 116th Avenue NE,
Bellevue, WA 98004, U.S.A.
Phone : +1 (425) 454-8155
Fax : +1 (425) 454-1509
E-mail : sales@icomamerica.com
URL : <http://www.icomamerica.com>

Icom New Zealand

146A Harris Road, East Tamaki,
Auckland, New Zealand
Phone : +64 (09) 274 4062
Fax : +64 (09) 274 4708
E-mail : inquiries@icom.co.nz
URL : <http://www.icom.co.nz>

Icom (UK) Ltd.

Unit 9, Sea St., Herne Bay,
Kent, CT6 8LD, U.K.
Phone : +44 (0)1227 741741
Fax : +44 (0)1227 741742
E-mail : info@icomuk.co.uk
URL : <http://www.icomuk.co.uk>

Asia Icom Inc.

6F No. 68, Sec. 1 Cheng-Teh Road,
Taipei, Taiwan, R.O.C.
Phone : +886 (02) 2559 1899
Fax : +886 (02) 2559 1874
E-mail : sales@asia-icom.com
URL : <http://www.asia-icom.com>

Icom Canada

Glenwood Centre #150-6165 Highway 17,
Delta, B.C., V4K 5B9, Canada
Phone : +1 (604) 952-4266
Fax : +1 (604) 952-0090
E-mail : info@icomcanada.com
URL : <http://www.icomcanada.com>

Icom (Europe) GmbH

Communication Equipment
Himmelgeister Str. 100,
D-40225 Düsseldorf, Germany
Phone : +49 (0)211 346047
Fax : +49 (0)211 333639
E-mail : info@icom-europe.com
URL : <http://www.icomeurope.com>

Icom France s.a.s.

Zac de la Plaine,
1 Rue Brindejone des Moulinais, BP 45804,
31505 Toulouse Cedex 5, France
Phone : +33 (5) 61 36 03 03
Fax : +33 (5) 61 36 03 00
E-mail : icom@icom-france.com
URL : <http://www.icom-france.com>

Beijing Icom Ltd.

10007, Long Silver Mansion, No.88, Yong Ding
Road, Haidian District, Beijing, 100089, China
Phone : +86 (010) 5889 5391/5392/5393
Fax : +86 (010) 5889 5395
E-mail : bjicom@bjicom.com
URL : <http://www.bjicom.com>

Icom (Australia) Pty. Ltd.

Unit 1 / 103 Garden Road,
Clayton, VIC 3168 Australia
Phone : +61 (03) 9549 7500
Fax : +61 (03) 9549 7505
E-mail : sales@icom.net.au
URL : <http://www.icom.net.au>

Icom Spain S.L.

Ctra. Rubí, No. 88 "Edificio Can Castanyer"
08190, Sant Cugat del Valles, Barcelona, Spain
Phone : +34 (93) 590 25 70
Fax : +34 (93) 589 04 46
E-mail : icom@icomspain.com
URL : <http://www.icomspain.com>

Icom Polska

Sopot, 3 maja 54, Poland
Phone : +48 (58) 550 7135
Fax : +48 (58) 551 0484
E-mail : icompolska@icompolska.com.pl
URL : <http://www.icompolska.com.pl>

Your local distributor/dealer: